



Summit Audio Inc.®

Summit Audio Model TLA-50 Tube Leveling Amplifier



Operation Manual

Summit Audio, Inc.
P.O. Box 223306
Carmel, CA 93922
(831) 728-1302
email: sound@summitaudio.com

Introduction

The Summit Audio Tube Leveling Amplifier is a hybrid of technologies. It contains both vacuum tube and solid state components. This combination of old and new technology produces an incredibly warm and smooth sounding compression device without the inherent disadvantages of the older designs.

Features

- Ease of Operation
- “Soft Knee” Characteristic
- Switch Selectable Attack and Release Settings
- Side Chain Access
- Stereo Coupling Capability
- Balanced and Unbalanced Inputs
- Balanced and Unbalanced Outputs
- Hand Crafted in the U.S.A.

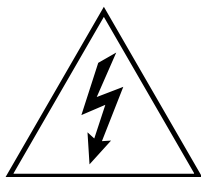

DANGER!
HIGH VOLTAGE

Carefully unpack the TLA-50 and its power cord. Save the carton and packing material for possible future use. Before powering up the unit, read this manual and observe the cautions for **HIGH VOLTAGE**.

- **IMPORTANT:** Check the back panel to make sure the TLA-50 is configured for the voltage used in your country. This is done at the factory **ONLY**.

Front Panel



Attack Switch

A three-position switch with **Fast**, **Medium** and **Slow** settings which control the time it takes the TLA-50 to respond to the incoming signal,

Release Switch

This three-position switch controls the time it takes the TLA-50 to return to unity again. As with the Attack Switch, there are three settings: **Fast**, **Medium** and **Slow**.

The release time setting is also controlled by the program material. The slower the release time setting, the more the program material determines and the release time.

Meter Switch

This control switches the front panel meter to monitor either the output level or the amount of gain reduction taking place.

Gain

This control sets the overall gain of the TLA-50. It controls the **Output Level** which can be monitored on the front panel meter.

Gain Reduction

This knob controls the amount of gain reduction taking place, and the operating point (threshold) where gain reduction begins. The higher the amount of gain reduction, the higher the compression ratio becomes.

Bypass Switch

This is a three-position switch. In the **BYPASS** mode, the compression cell and the 12AX7/ECC83 tube are removed from the signal chain.

In the center **IN** position, the TLA-50 is switched into the audio path.

In the left or **LINK** position, two TLA-50 units can be linked together by connecting the Stereo Link jacks together with a standard 1/4" cable.

Power

This switch toggles AC power on and off.

Important - Please Read!

The TLA-50 contains a vacuum tube which generates heat.

Do not block the cooling holes on the top of the TLA-50 and always allow adequate ventilation when mounting the unit in a rack enclosure.

Rear Panel

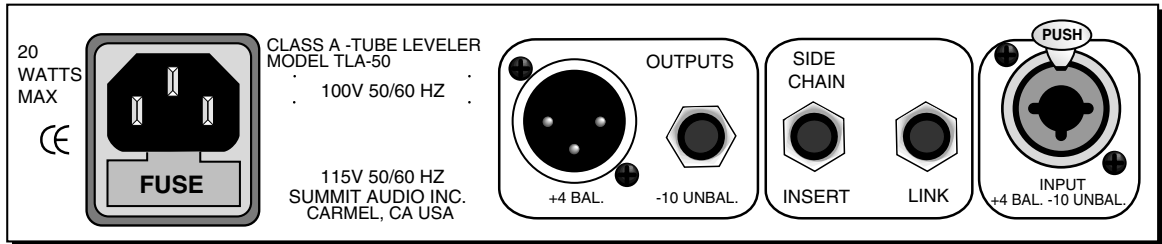

A.C. Receptacle

The TLA-50 is factory wired for either 100, 115 or 230 Volts AC. Before connecting AC power make sure the TLA-50 is wired for the voltage used in your country.

+4 Balanced Output

Balanced outputs provide superior noise immunity in the studio and when using long cable runs. +4 dBm corresponds to 0 VU. The output connector is wired as follows:

Pin 1= Ground, Pin 2 = (+) Signal, Pin 3 = (-) Signal.

-10 Unbalanced Output

Connect the unbalanced output to equipment with unbalanced inputs. 0 VU on the meter corresponds to -10dBm

Side Chain Insert

The side chain insert jack allows an equalizer to be inserted in order to perform frequency selective compression.

A separate signal can also be connected to the tip of the jack in order to duck the signal running through the TLA-50.

Stereo Link

Two TLA-50's can be linked to process stereo signals. When two units are linked in this way, the leveling action will be the same on both units. The TLA-50 providing the most compression will always control the other unit.

To "stereo link" two units:

1. Connect a standard 1/4" cable between the two units.
2. Set the controls on both units the same.
3. Set the BYPASS switch on the front panel to LINK.

Balanced Input

The dual purpose input jack accepts XLR plugs for balanced inputs and standard 1/4" plugs for unbalanced inputs. Input impedance is 20KΩ. Maximum signal input level is +26dBm.

Basic Operation

Important: For proper operation of the TLA-50 (or any vacuum tube device for that matter), allow the unit to warm up with power on for 15 minutes before use.

Important: Do not block the cooling holes and allow adequate ventilation.

Four Easy Steps

1. Set the Gain Reduction control to 0 and adjust the Gain control for 0 VU on the meter.
2. Switch the attack to slow and the release to fast.
3. Adjust for the desired amount of gain reduction and recheck the output level.
4. Try different attack and release settings, depending upon the program.

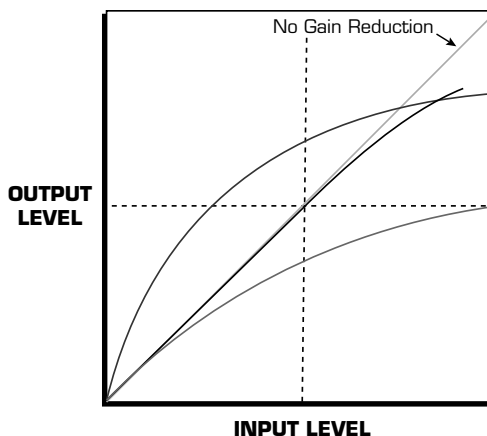

As the amount of gain reduction is increased, the processed audio follows a smooth reduction curve, thereby changing the compression ratio.

If a large peak is detected, the unit will automatically increase the compression ratio to keep the audio output controlled.

Applications

Tracking, Live Sound Mixing

Plug the TLA-50 into the insert jack or patch bay of your mixing console. If you're using an external microphone preamplifier, connect the TLA-50 directly after the preamp.

Insert Connection

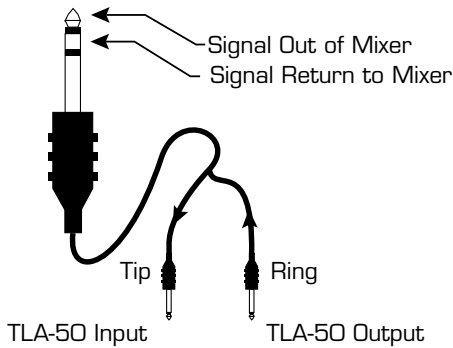

INSERT CABLE

Signal is sent out on tip of plug and returned to mixer via ring of plug.

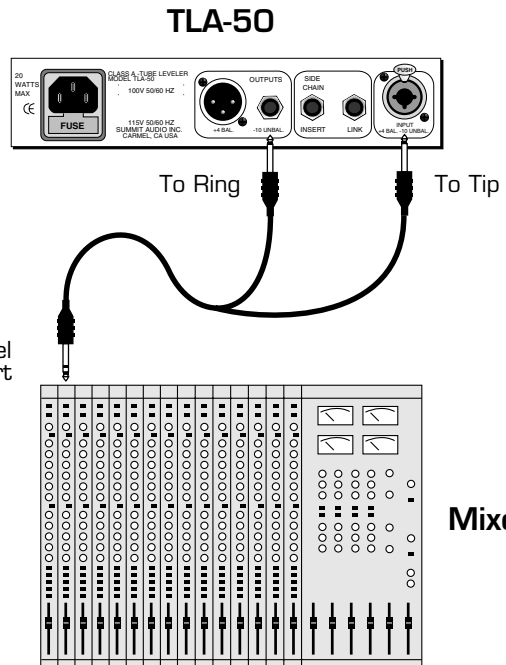

Basic In-line Connection of the TLA-50

Inline Connection

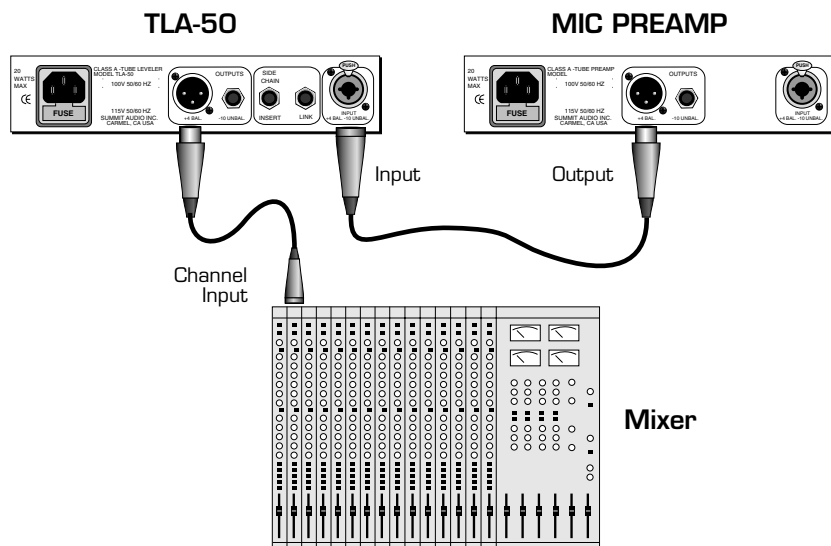

Compressing a Stereo Mix

Insert a 1/4" cable into two TLA-50's link jacks, set the attack and release switches and gain reduction on both units to the same settings. Put both units in link mode. The channel with the strongest signal will lead both units.

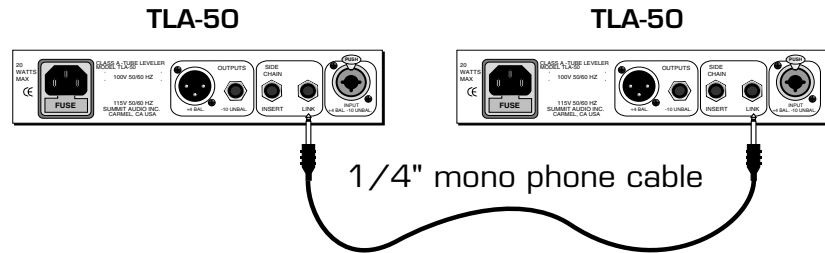

Set controls to the same settings on both units.

De-essing

Plug a TRS insert cable into the side chain jack on the back of the TLA-50. Plug the send (tip) of the insert cable to the input of an EQ, and the return (ring) of the cable to the EQ output. Boost the frequencies on the EQ that you want to compress (de-ess).

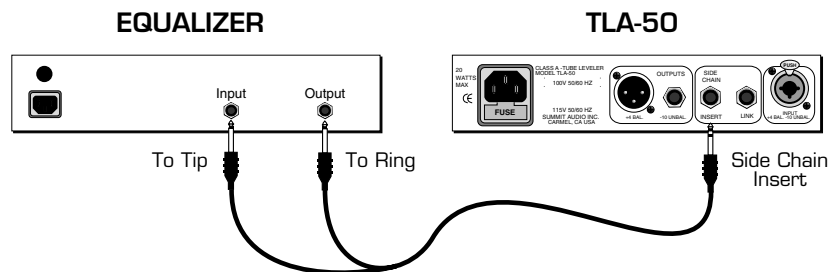

Ducking

Send the output of the “lead” program material into the side chain return after inserting the TLA-50 on the “background” program material.

Example

Send the output of a vocal mic into the side chain, with the TLA-50 inserted on the lead guitar track. As the singer uses the vocal mic, the lead guitar will decrease in amplitude.

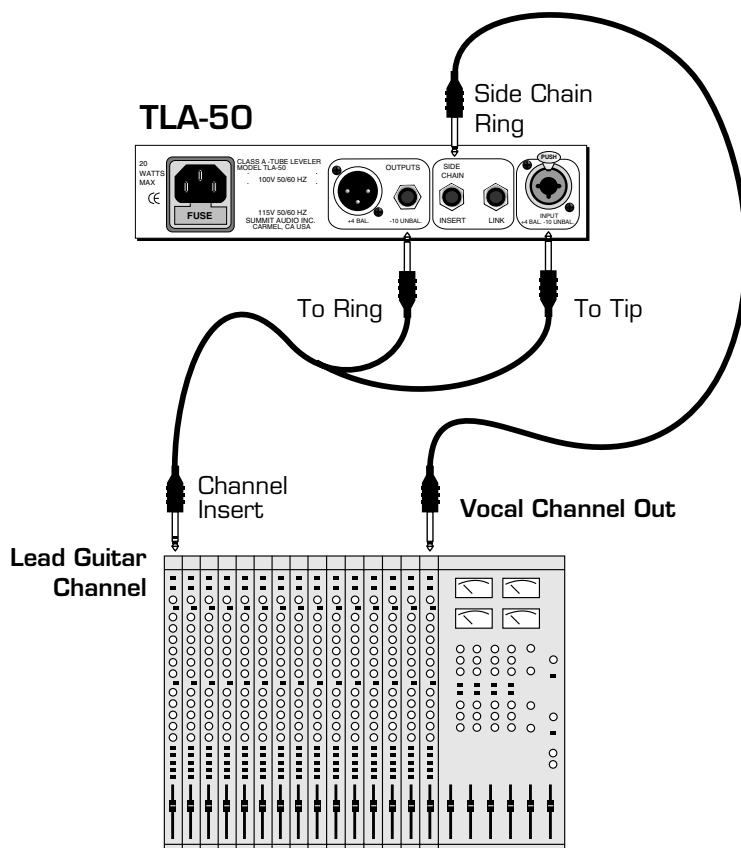

Warning: *Set the TLA-50's gain reduction to 0 with the unit in "In" mode (not bypassed). All audio will then pass through the vacuum tube without compressing. Adding a small amount of compression at this point will increase the high frequency response.*

Using the TD-100 and TLA-50 together

For a great bass or guitar channel, try using the Summit Audio TD-100 instrument preamp and tube direct box in conjunction with the TLA-50.

Plug your instrument into the front panel of the TD-100 (*see the TD-100 manual for more info*) and run an XLR or 1/4" cable from the output of the TD-100 to the input of the TLA-50. Use the 1/4" output of the TD-100 into the TLA-50 to go directly from the TLA-50 to your recording device, or use the XLR output of the TD-100 into the TLA-50 and patch the XLR output of the TLA-50 into a microphone preamp, then into your recording device.

Circuit Explanation

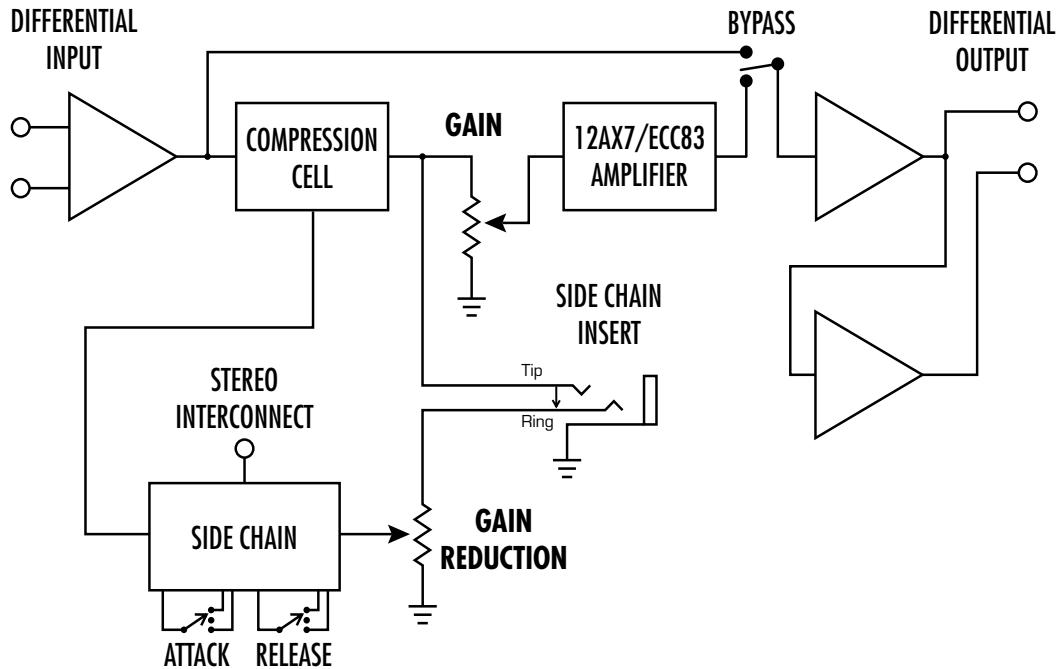

The input to the TLA-50 is electronically balanced and directly feeds the unique compression cell. The SIDE CHAIN allows for stereo coupling or the insertion of an equalizer. Due to the combination of tube and solid state circuitry, long term drift of the compression circuit is minimal and tracking between two TLA-50's stereo linked is within .3dB.

The TLA-50 features a vacuum tube amplifier driving an electronically balanced output stage. All the signal amplification in the audio path takes place in the tube circuit. The balanced output drivers provide a low output impedance for driving cables and 600Ω loads.

Electrical Connections

Input

Note: *The Input connector accepts either a 1/4" phone plug or an XLR connector.*

Unbalanced 1/4" jack

Sleeve - - Ground
Tip - - - - (+) Signal

Balanced 3-pin XLR

Pin 1 - - Ground
Pin 2 - - (+) Signal
Pin 3 - - (-) Signal

Output

Unbalanced 1/4" jack

Sleeve - - Ground
Tip - - - - (+) Signal

Balanced 3-pin XLR

Pin 1 - - Ground
Pin 2 - - (+) Signal
Pin 3 - - (-) Signal

Side Chain

Tip - - - - Signal output to EQ
Ring - - - Signal input (from EQ)
Sleeve - - Ground

Stereo Link

Tip - - - - Signal
Sleeve - - Ground
Use a shielded patch cord with 1/4" plug.

Specifications

Output

+4 dBm corresponds to 0 VU. The output is electronically balanced or unbalanced. Output impedance is 75 Ω . The recommended output load is 600 Ω or greater. Maximum output is HOT at approximately +29 dBm.

Input

The input is electronically balanced or unbalanced. Input impedance is 20k Ω . Maximum input level is +26dBm.

Power

20 watts

115 volts

50 or 60 Hz

Fuse size is .5 amp, slo-blo for 100/115 V

Fuse size is .25 amp, slo-blo at 230 V

Dimensions

W: 8.5", **H:** 1.75", **D:** 8.5" *(Two units fit side by side on a standard one-space rack shelf.)*

Weight

4.4 pounds (2 kg)



Summit Audio Inc.®

Summit Audio, Inc.

P.O. Box 223306

Carmel, CA 93922

web page: www.summitaudio.com

email: sound@summitaudio.com

Please fill in and mail your warranty card today. We would like to know a little bit about you. We will provide periodic updates, links, announcements and even free stuff. Be sure to include your email address if you have one. Thanks.